

**BELLEVUE 148TH SOUTHEAST AT LARSEN  
LAKE FLOOD MITIGATION  
ALTERNATIVE 3A, 3B, 3C, 3D  
FILL ONLY**

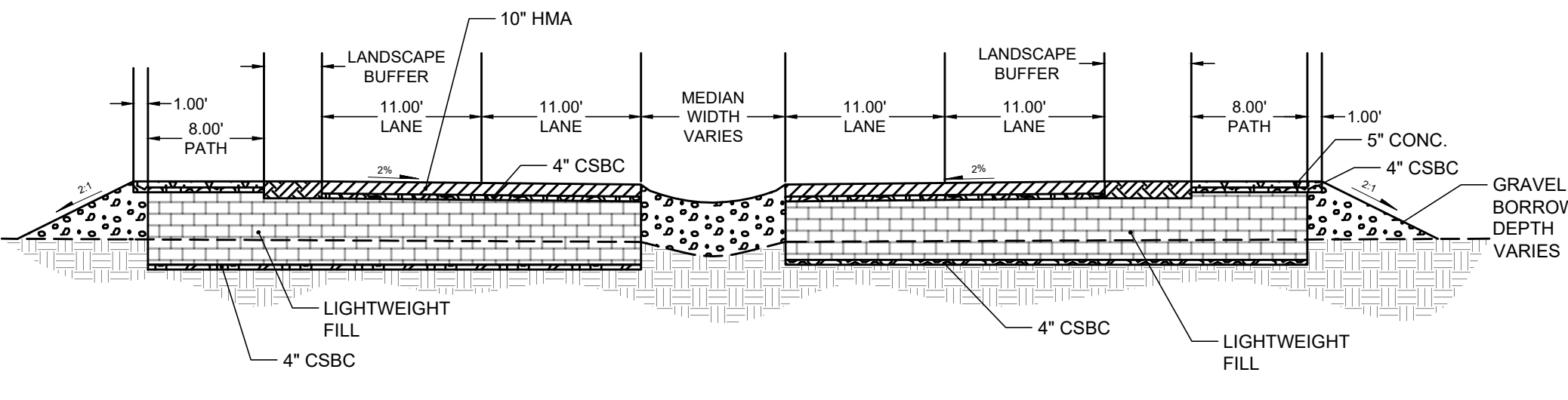

**LIGHTWEIGHT FILL SECTION  
NTS**

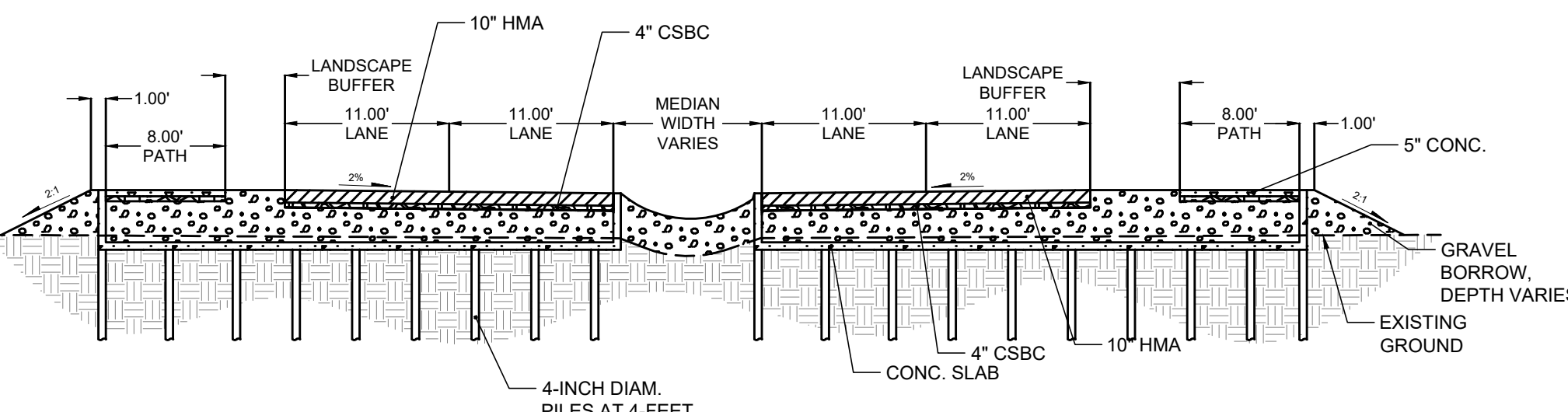

**PIN-PILE SUPPORTED SLAB SECTION  
NTS**

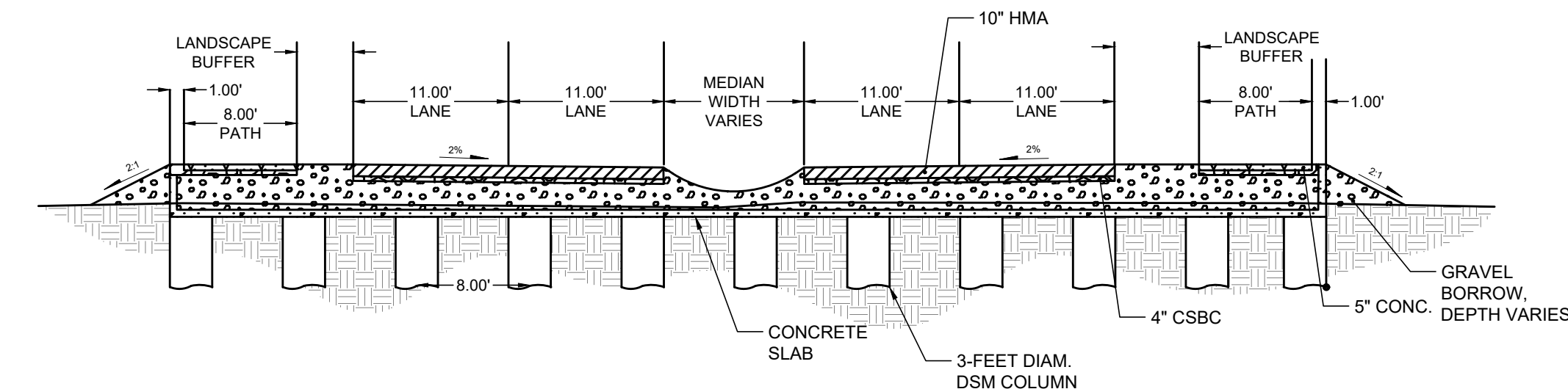

**GROUND IMPROVEMENT SECTION  
NTS**

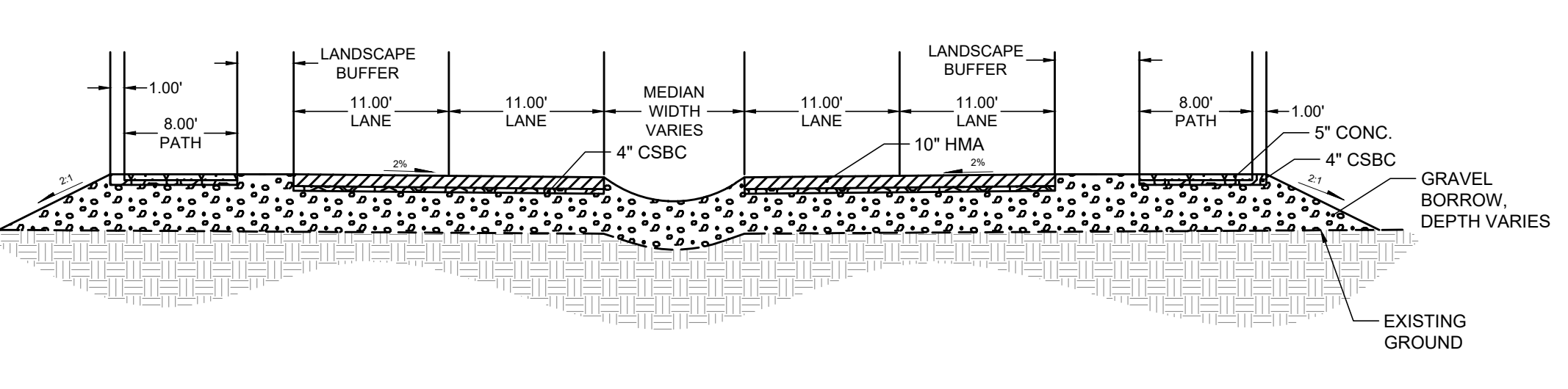

**OVER-FILL SECTION  
NTS**


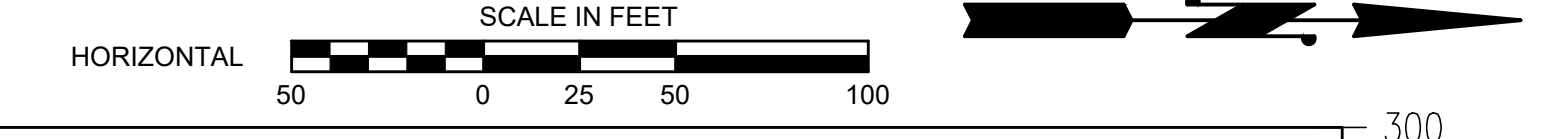


## BELLEVUE 148TH SOUTHEAST AT LARSEN LAKE FLOOD MITIGATION ALTERNATIVE 3A, 3B, 3C, 3D WALLS ONLY

